

## UNI INJECTOR PULLER KIT

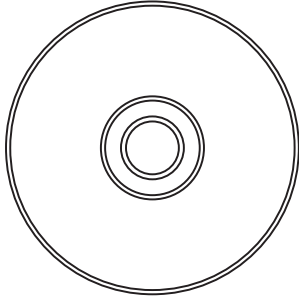

# 600 130-1  
Hammer

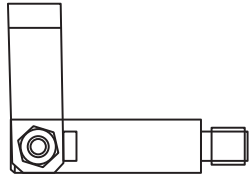

# 600 130-5  
Joint Adapter

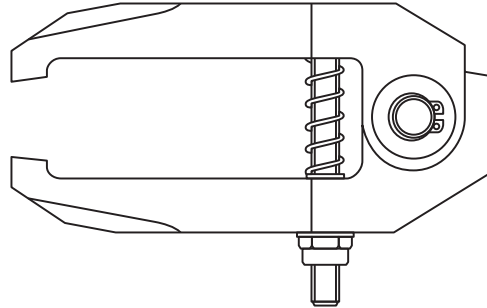

# 600 130-2  
Adjustable Plier

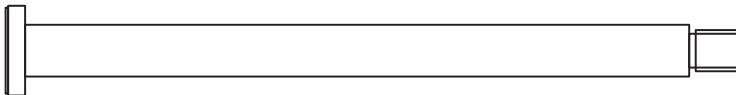

# 600 130-3  
Slide Hammer Rod Long

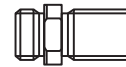

# 600 130-6  
Adapter AG  
M14x1,5/M14x1,0

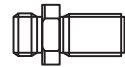

# 600 130-7  
Adapter AG  
M12x1,5/M12x1,0

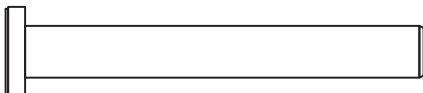

# 600 130-4  
Slide Hammer Rod Short



# 600 130-9  
Handle with inner thread M12x1,5



# 600 130-8  
Pulling Hook



# 600 130-10  
Handle with inner thread M14x1,5



# 600 130  
UNI INJEKTOR PULLER KIT

**Universal kit for diesel injectors.** Fits Bosch, Delphi, Denso, and Siemens. Will work in most cases without removing the electric plug.

# 600 130 Uni Injector puller kit